

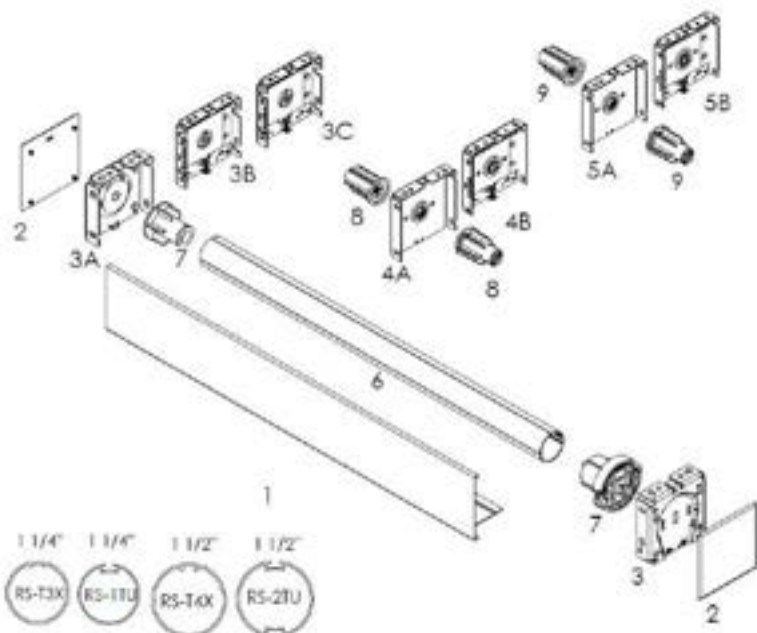













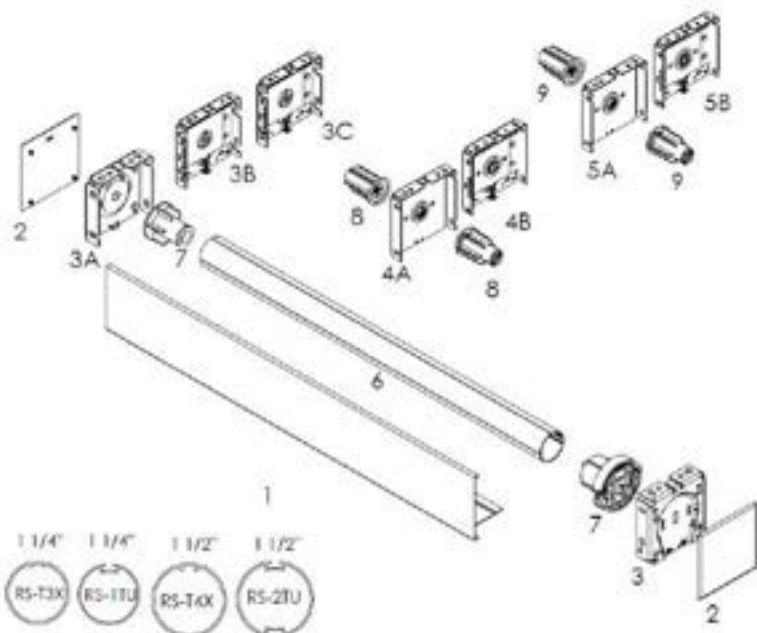

3" Fascia System with RS Clutch



#	DESCRIPTION	ITEM #			
1	3" Fascia	Square 	Square with F.I. 	Curve 	Curve with F.I. 
		RS-SA1~5	RS-TA1~5	RS-SB1~5	RS-ST1~5
2	3" Fascia End Cap	RS-UH1~5/VT1~5	RS-VH1~5	RS-UJ1~5	RS-VN1~5
3A	3" Fascia Bracket for RS Clutch	1.25"	RS-UA1~5	1.5"	RS-UB1~5
3B	3" Adj. Fascia Bracket for RS Clutch	1.25"	RS-UHA~E	1.5"	RS-UIA~E
3C	3" Adj. Fascia Bracket for RS Clutch with 8mm Bushing	1.25"	RS-UHF~J	1.5"	RS-UIF~J
4A	3" Intermediate Fascia Bracket		RS-WB1~5		
4B	3" Adj. Intermediate Fascia Bracket		RS-WBA~E		
5A	3" Center Support Fascia Bracket		RS-WC1~5		
5B	3" Adj. Center Support Fascia Bracket		RS-WCA~E		
6	Tube	1 1/4" 	1 1/4" 	1 1/2" 	1 1/2" 
		RS-T30/32/36	RS-1TU	RS-T40/42/46	RS-2TU
7	RS Clutch	RM-1CR	RM-1CX/1BX/220	RM-2CR	RM-2CX/2BX/221/223
8	Tube Idle End for Inter. Bracket	-	-	RS-WQ5/RS-WM2	RS-WQ1/RS-WM1
9	Tube Idle End for Center Support Bracket	-	-	RS-WQ6	RS-WQ3







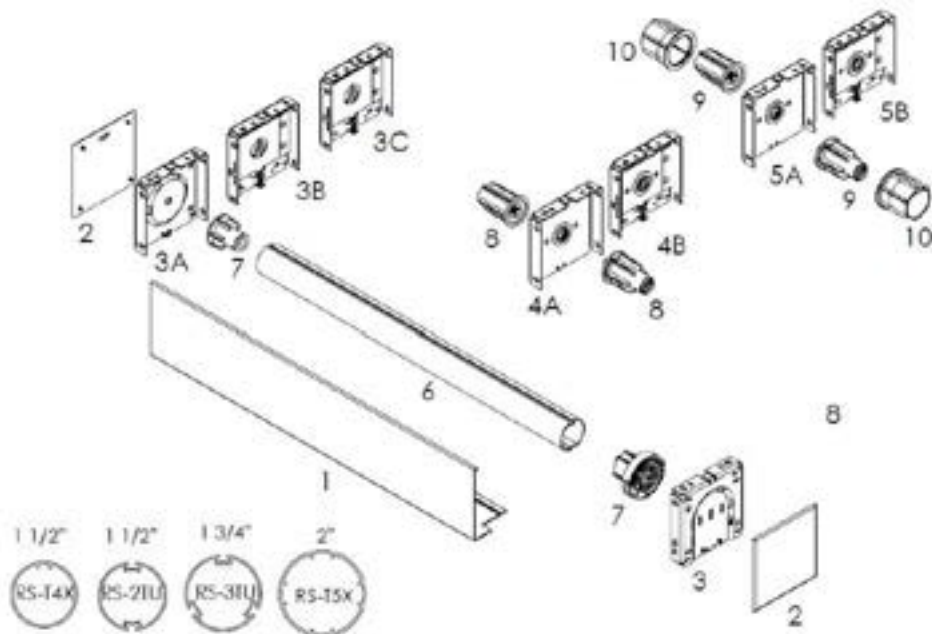

3" Fascia System with RS Clutch



#	DESCRIPTION	ITEM #			
1	3" Fascia	Square 	Square with F.I. 	Curve 	Curve with F.I. 
		RS-SA1~5	RS-TA1~5	RS-SB1~5	RS-ST1~5
2	3" Fascia End Cap	RS-UH1~5/VT1~5	RS-VH1~5	RS-UJ1~5	RS-VN1~5
3A	3" Fascia Bracket for RS Clutch	1.25" RS-UA1~5	1.5" RS-UB1~5		
3B	3" Adj. Fascia Bracket for RS Clutch	1.25" RS-UHA~E	1.5" RS-UIA~E		
3C	3" Adj. Fascia Bracket for RS Clutch with 8mm Bushing	1.25" RS-UHF~J	1.5" RS-UIF~J		
4A	3" Intermediate Fascia Bracket		RS-WB1~5		
4B	3" Adj. Intermediate Fascia Bracket		RS-WBA~E		
5A	3" Center Support Fascia Bracket		RS-WC1~5		
5B	3" Adj. Center Support Fascia Bracket		RS-WCA~E		
6	Tube	1 1/4" 	1 1/4" 	1 1/2" 	1 1/2" 
		RS-T30/32/36	RS-1TU	RS-T40/42/46	RS-2TU
7	RS Clutch	RM-1CR	RM-1CX/1BX/220	RM-2CR	RM-2CX/2BX/221/223
8	Tube Idle End for Inter. Bracket	-	-	RS-WQ5/RS-WM2	RS-WQ1/RS-WM1
9	Tube Idle End for Center Support Bracket	-	-	RS-WQ6	RS-WQ3

4" Fascia System with RS Clutch



#	DESCRIPTION	ITEM #			
1	4" Fascia	Square 	Square with F.I. 	Curve 	Curve with F.I. 
		RS-SC1~5	RS-TB1~5	RS-SD1~5	RS-SU1~5
2	4" Fascia End Cap	RS-UI1~5/VU1~5	RS-VI1~5	RS-UK1~5	RS-VP1~5
3A	4" Fascia Bracket for RS Clutch	1.5"	RS-UC1~5	1.75"/2"	RS-UD1~5
3B	4" Adj. Fascia Bracket for RS Clutch	1.5"	RS-UJA~B	1.75"/2"	RS-UKA~E
3C	4" Adj. Fascia Bracket for RS Clutch with 8mm Bushing	1.5"	RS-UJF~J	1.75"/2"	RS-UKF~J
4A	4" Intermediate Fascia Bracket				RS-WD1~5
4B	4" Adj. Intermediate Fascia Bracket				RS-WDA~E
5A	4" Center Support Fascia Bracket				RS-WE1~5
5B	4" Adj. Center Support Fascia Bracket				RS-WEA~E
6	Tube	1 1/2" 	1 1/2" 	1 3/4" 	2" 
		RS-T40/42/46	RS-2TU	RS-3TU/RS-T76	RS-T52/56/57
7	RS Clutch	RM-2CR	RM-2CX/2BX/221/223	RM-3CX/3BX/222/224	RM-3CR
8	Tube Idle End for Inter. Bracket	RS-WQ5/RS-WM2	RS-WQ1/RS-WM1	RS-WQ2/RS-WM3	RS-WM4
9	Tube Idle End for Center Support Bracket	RS-WQ6	RS-WQ3	RS-WQ4	RS-WQ6
10	Adaptor	-	-	-	Z-10G

4" Smart Cassette with RS Clutch

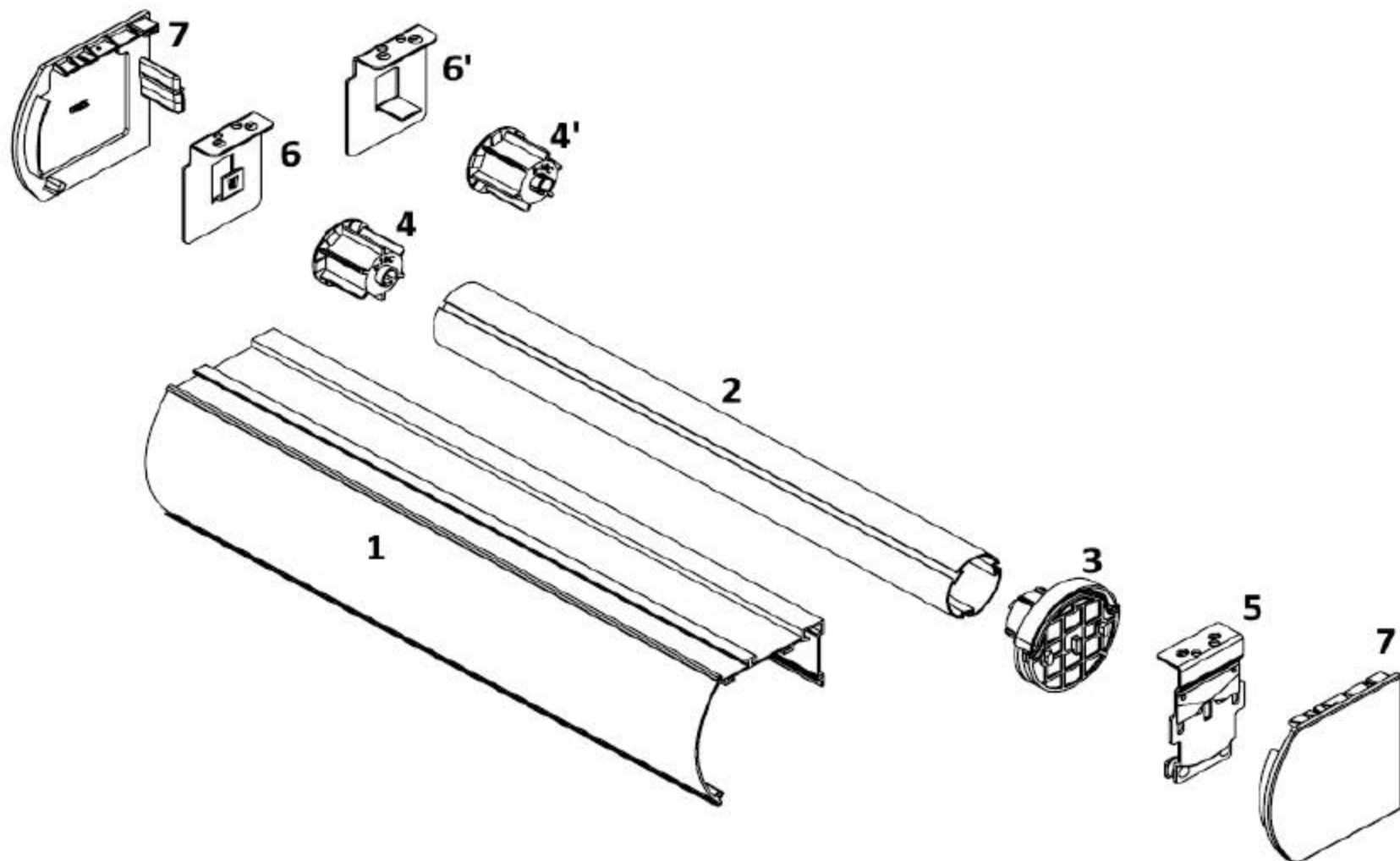

#	DESCRIPTION	ITEM #
1	4" Smart Cassette	With Inserted Fabric: ST-C21~5& ST-012 Smooth: ST-C31~5
2	Tubes	1.75" tube: RS-3TU/T76 2" tube : RS-T56/T57
3	RS-CLUTCHES	1.75" tube: RM-3X0 2" tube : RM-3R0
4	Plug End	1.75" tube : Z-10C/10D 2" tube : Z-10A & Z-10G
4'	Plug End with Slot	1.75" tube : Z-20C 2" tube : Z-20A & Z-10G
5	4" Smart Cass. Brkt for RS3CX clutch end	ST-E27
6	4" Smart Cass. Brkt for Idle End	Adjustable: ST-E25 Non-Adj.: ST-E24
6'	4" Smart Cass. Brkt for XR clutch end	ST-E22/E23
7	4" Smart Cass. End Cap	with Clip: ST-B61~5 no-clip: ST-B71~5 (FOR Roller Shade ONLY)